



FOOD WASTE REDUCTION SYSTEM

PRODUCT FEATURES & SPECIFICATIONS



- Up to 85% volume reduction
- Capacity 700 lbs (317.5 kg) of waste per hour
- Fits under standard table – minimum height 34" (863.6 mm)
- Does not require cardboard
- Stainless steel construction
- Quick and easy to clean – no tools required
- One year full warranty
- Processes 100% food waste or up to 50% disposables
- NEMA 4 stainless steel electrical control panel
- Removeable auger and screen
- Interlock on discharge chute
- Water usage 2-5 GPM (7.6-18.9 LPM) – sink or bowl configuration
- Trough application – contact factory



ELECTRICAL SPECIFICATIONS

- WX-8 – 208-230V, 60 Hz, 3 Ph, 7.7/9.4 amps (Disposer 6.0/7.4 amps, WX 1.7/2 amps)
- WX-9 – 460V, 60 Hz, 3 Ph, 4.7 amps (Disposer 3.7 amps, WX 1 amp)

DISPOSER MOUNTING ASSEMBLIES

-  #6 Collar Adaptor for welding into trough or sink, provides 6-5/8" (168.3 mm) opening, includes splash baffle
-  18" Type A Sink Bowl Assembly with two water nozzles, includes removable splash baffle and stainless bowl cover

ACCESSORIES

- Reel Rinse Spray Unit (Fisher #2980)
- Pre-Rinse Spray with wall bracket (Fisher #2010-WB)
- Pre-Rinse Spray with wall bracket - Ultra Spray (1.6 GPM) (6.1 LPM) (Fisher #2010-1WB)
- Trough Nozzle - 1" (25.4 mm) NPT
- WXP Inlet/Outlet Flange - 2" (50.8 mm) NPT (secondary) (Trough or high water flow applications)
- Dejamming Wrench

Our products appear on **The KCL CADalog** CD-ROM based CAD Foodservice Symbol Library. More information is available from **Kochman Consultants, Ltd.** at www.kclcad.com.



4700 21st STREET
 RACINE, WI 53406-5093
 TEL: 800-845-8345
 FAX: 262-554-3620
www.insinkerator.com



The Emerson logo is a trademark and a service mark of Emerson Electric Co.



SYSTEM COMPONENTS

This System Includes:

- Waste Xpress Unit
- 3 HP Disposer
- Disposer mount (collar or bowl)
- Syphon Breaker
- Flow Control Valve 5 GPM (18.9 LPM)
- Magnetic Silver Saver
- 10 gallon (37.9 liter) Waste Can
- 3" (76.2 mm) to 2" (50.8 mm) disposer waste outlet reducer fitting
- (2) 24V Water Solenoids
- WX-101A Control Center

Items Supplied by Others:

- Plumbing from cold water supply to bowl or trough
- Plumbing from hot water supply to Waste Xpress
- Plumbing from disposer to Waste Xpress or Waste Xpress to floor sink or floor drain
- Shut off valves
- Electrical connections

TYPICAL INSTALLATION

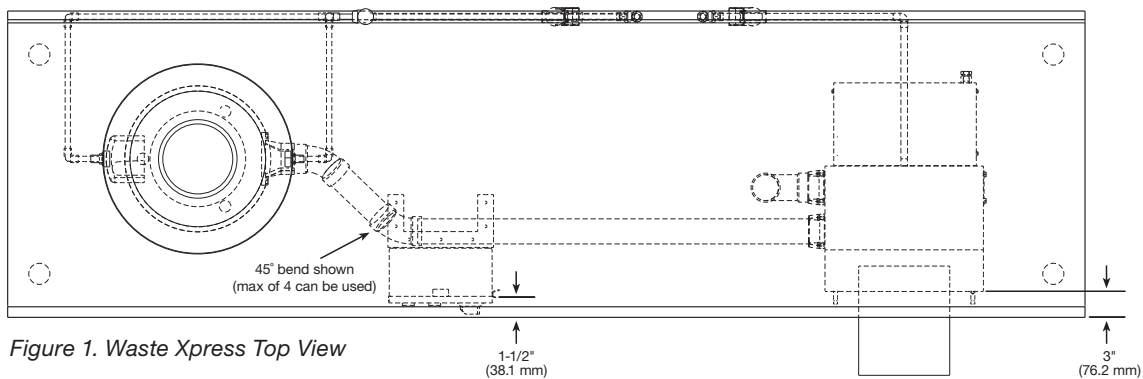

Figure 1. Waste Xpress Top View

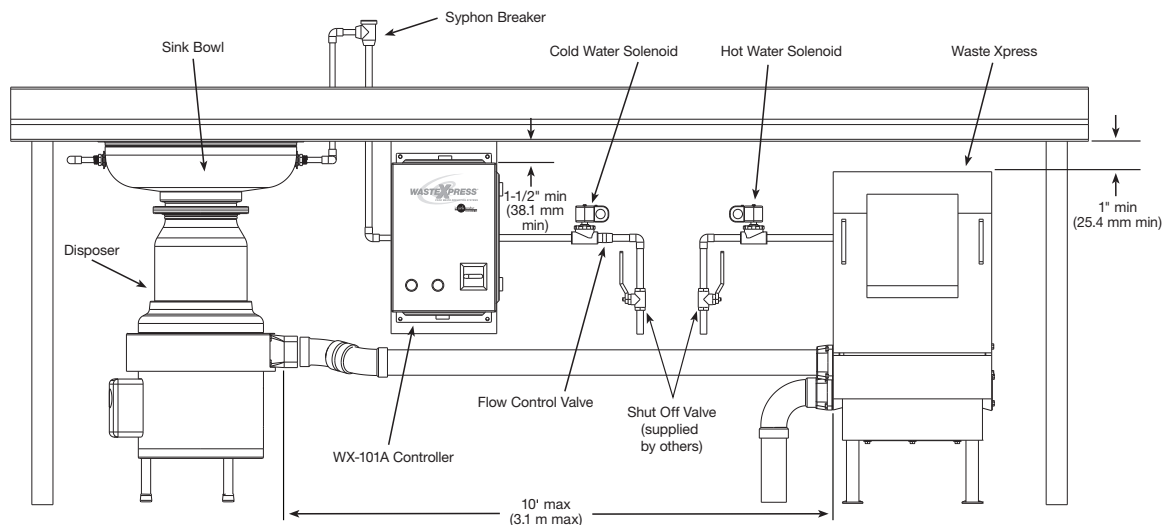

Figure 2. Waste Xpress Typical Installation

GENERAL NOTES

Disposer

- Install the disposer per the Instruction, Care and Use manual.
- When positioning disposer ensure that the overload reset button is accessible by end user.
- Connect cold water to either the sink bowl or end of trough.

Waste Xpress

- Install the Waste Xpress per the Instruction, Care and Use manual.
- Position the pulper so that the front surface of the discharge chute is recessed 3" (76.2 mm) (see Figure 1) from the front edge of the table and that a minimum clearance of 1" (25.4 mm) exists between the underside of the table and top of the discharge chute (see Figure 2) for proper removal of discharge chute, ease of cleaning and general maintenance.
- Position the pulper so that it is within 10' (3.1 m) of the disposer outlet flange. (See Figure 2)

- The Waste Xpress should be disassembled and cleaned a minimum of once daily. Interior of cabinet and discharge chute should be cleaned with hot soapy water. Auger, screen and bearing bracket can be cleaned either manually with hot soapy water or in a dishwasher.

Control Panel

- Install the WX-101A control panel per the Instruction, Care and Use manual and in accordance to local, state and or national electric codes.
- Position the control panel so that the front surface is recessed 1-1/2" (38.1 mm) from the front edge of the table and that a minimum clearance of 2" (50.8 mm) exists between the underside of the table and the top of the control panel for ease of installation and serviceability.
- Position the WX-101A control panel so that it is within site of the disposer and pulper.

PLUMBING NOTES

Waste Connection

- 2" (50.8 mm) NPT – used between disposer, Waste Xpress and drain
- When connecting the drain line from the disposer to the Waste Xpress use a maximum of (4) 90° bends (45° bends are recommended) with a 1/4" (6.4 mm) drop per foot of run or as local codes apply.
- Floor sink or drains should be installed per local codes but kept clear of yet accessible to pulper.
- Trough applications in excess of 10' (3.1 m) and/or systems plumbed with a cold water supply greater than 7 GPM (26.5 LPM) must incorporate the second drain outlet from the pulper and be drained independently to floor sink or drain.

Fresh Water Connections

- 1/2" (12.7 mm) NPT – used on syphon breaker, solenoid and flow control valve.
- 1/2" (12.7 mm) NOM compression – used on sink bowl nozzles.
- 1/2" (12.7 mm) Ridged Copper (compression) – used on hot water connection to pulper.
- If fresh water supply is greater than 50 psi (144.7 kPa), a pressure regulating valve must be installed in both.
- It is recommend that ball type shutoff valves be installed in the cold and hot water lines.
- It is recommended that the hot water connected between solenoid valve and pulper be terminated with a union for ease of serviceability.

TROUGH APPLICATION NOTES

Construction

- The recommended maximum trough length is 10' (3.1 m).
- A silver saver should be fabricated prior to end of trough to catch utensils and dishes.

Water Supply

- For trough lengths of 10' (3.1 m) or less place water nozzle at end of trough.
- For trough lengths greater than 10' (3.1 m) place one water nozzle at end of trough and one mid stream.
- Do not plumb water to disposer grind chamber.

Magnet

- Can be mounted to trough either by tack welding to using weld studs (see instruction sheet for weld stud pattern).
- Trough magnets should be placed within 12" (304.8 mm) of end of trough or trough intersection with sink bowl (see Figure 4).
- Additional magnets can be used as necessary.

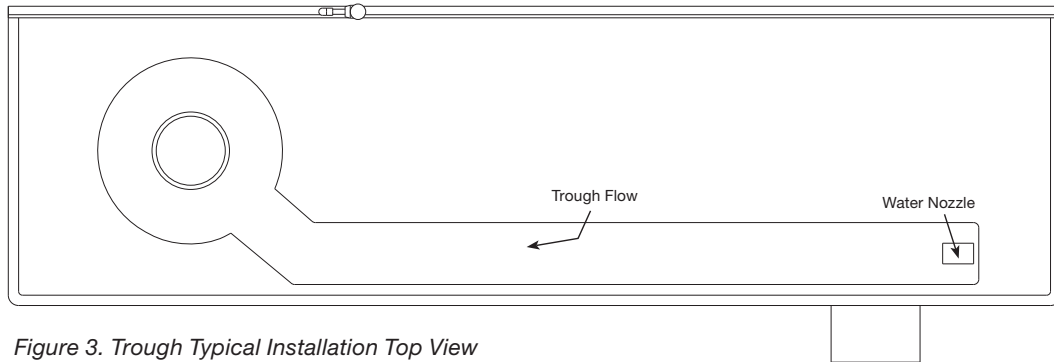

Figure 3. Trough Typical Installation Top View

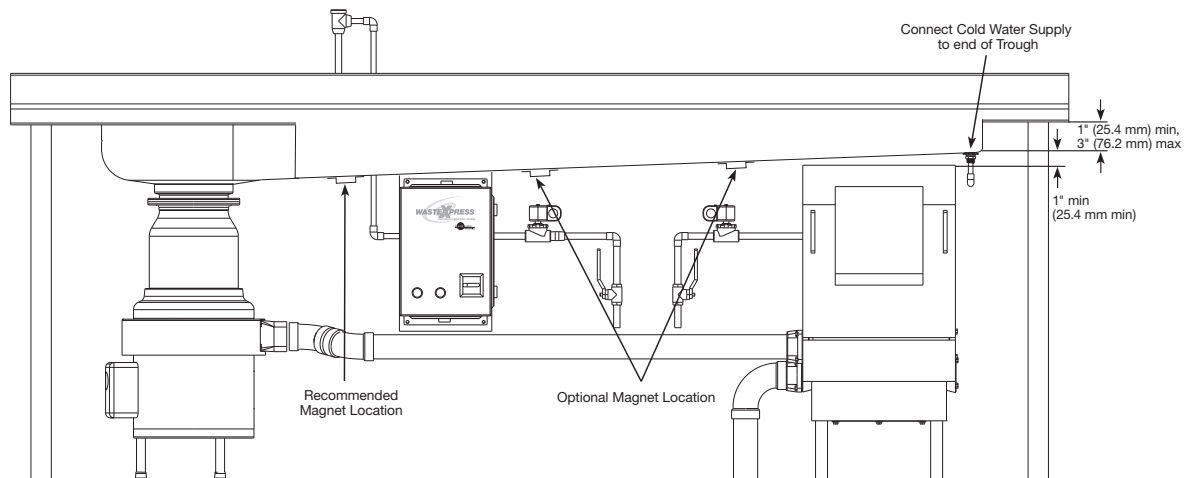
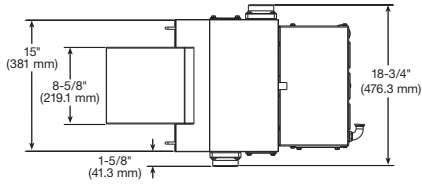
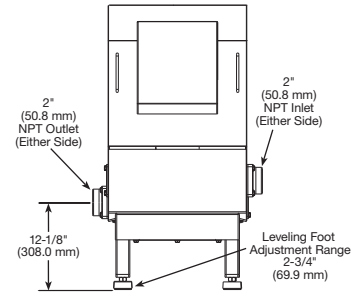

Figure 4. Trough Typical Installation

DIMENSIONS



Waste Xpress Top View



Waste Xpress Front View

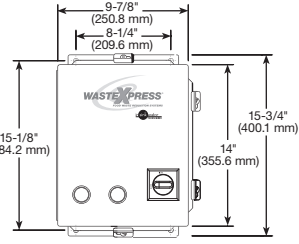

Control Center Front View

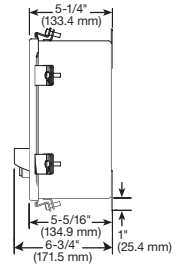

Control Center Side View

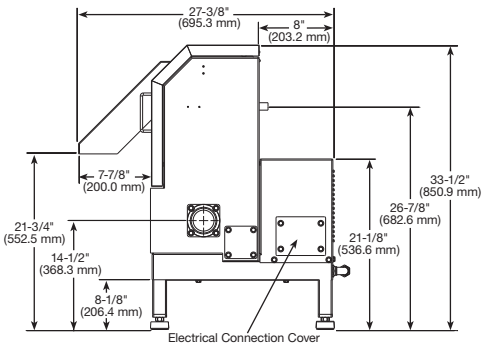

Waste Xpress Side View

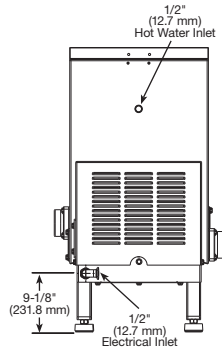

Waste Xpress Back View

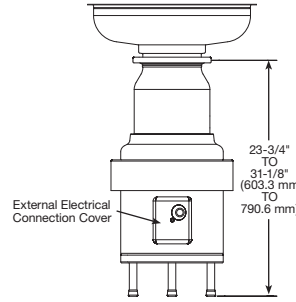

Disposer Front View

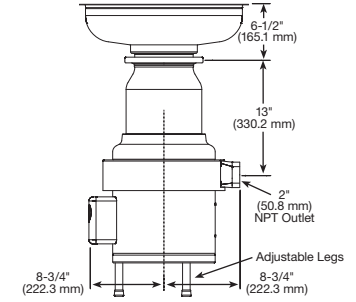

Disposer Side View

PROJECT INFORMATION

Item Number: _____

Model Number: _____

Quantity: _____

Electrical Requirements: _____ volts _____ phase

Manufacturer: InSinkErator

Project: _____

Dealer: _____

Address: _____

City/State/Zip: _____

City/State/Zip: _____

Contact: _____

Contact: _____

Phone: _____

Phone: _____

Installer: _____

Consultant: _____

Contact: _____

Contact: _____

Phone: _____

Phone: _____